



Historical Developments

ICS312 Machine-Level and Systems Programming

Henri Casanova (henric@hawaii.edu)



Historical Developments

- The history of “computers” is long and fascinating
- It should be part of your culture as computer scientists
 - Many books exist that detail the history of computers in many more details than what we can do in this course
- We’re going to proceed in “generations”
 - Nobody is in perfect agreement about these generations
 - But they are a convenient way to organize the history of computers
 - People disagree about the “first computer” as well

Generation 0: Mechanical Calculators

- Before the 1500s, in Europe, calculations were made with an **abacus**
 - Invented around 500BC, available in many cultures (China, Mesopotamia, Japan, Greece, Rome, etc.)
- In 1642, **Blaise Pascal** (French mathematician, physicist, philosopher) invented a mechanical calculator called the **Pascaline**
 - Additions, subtractions, carries
 - Initially used to help Pascal's father with Tax computations!
 - Survived in some shape or form until the early 20th century
- In 1671, **Gottfried von Leibniz** (German mathematician, philosopher) extended the Pascaline to do multiplications, divisions, square roots: the **Stepped Reckoner**
- None of these machines had memory, and they required human intervention at each step

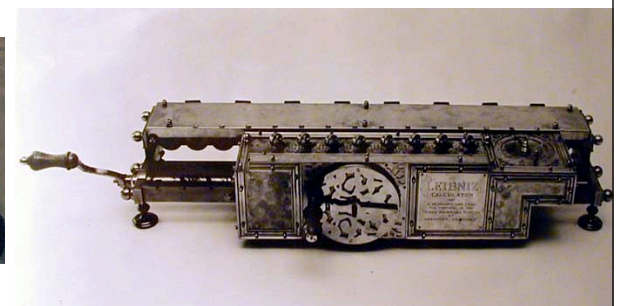
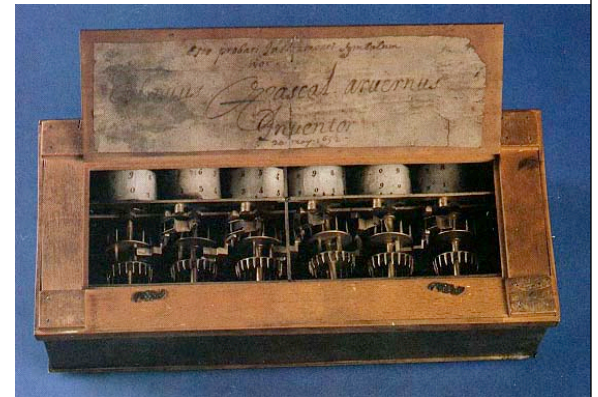
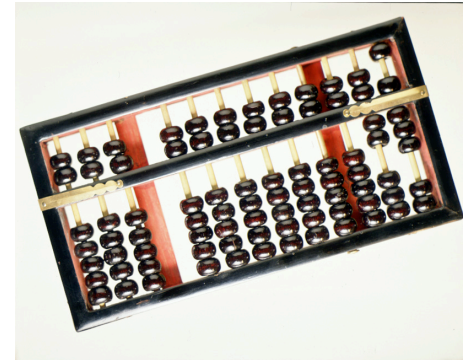

Generation 0: Babbage

- In 1822 **Charles Babbage** (English mathematician, philosopher), sometimes called the “father of computing” built the **Difference Engine**
- Machine designed to automate the computation of polynomial functions (which are known to be good approximations of many useful functions)
 - Based on the “method of finite difference” by which polynomial values can be computed without ever having to do a multiplication
 - Implements some storage
 - All internal and temporary, the user doesn't store anything
 - Let's check out [this video...](#)

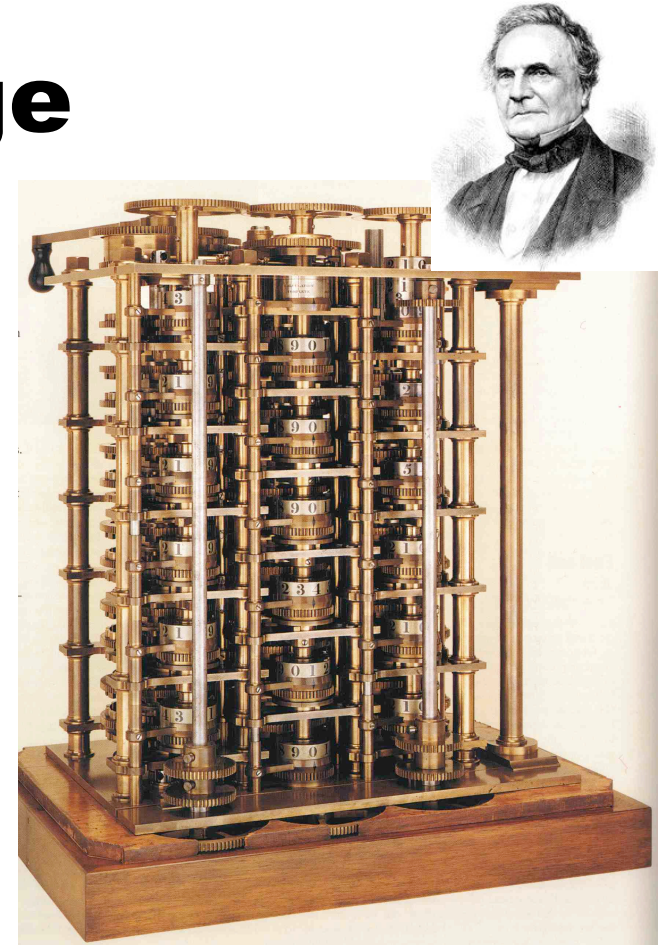

Generation 0: Babbage



- In 1833 Babbage designed the **Analytical Engine**, but he died before he could build it
 - It was built after his death, powered by steam!
- It was much more general than the difference engine, and could in theory perform “any” mathematical operation
- This is really the first machine that somewhat resembles our computers
 - An arithmetic processing unit (the mill)
 - A memory (the store)
 - Input/output devices (punched metal cards)
 - Inspired by Jacquard automatic weaving loom!
 - Convenient for “wheeled” machines
 - A conditional branching instruction!
- In 1842, **Ada Lovelace** (English mathematician, daughter of Lord Byron) wrote instructions for the Analytical Engine to compute the Bernoulli numbers: the first computer program!
 - A programming language is named after her

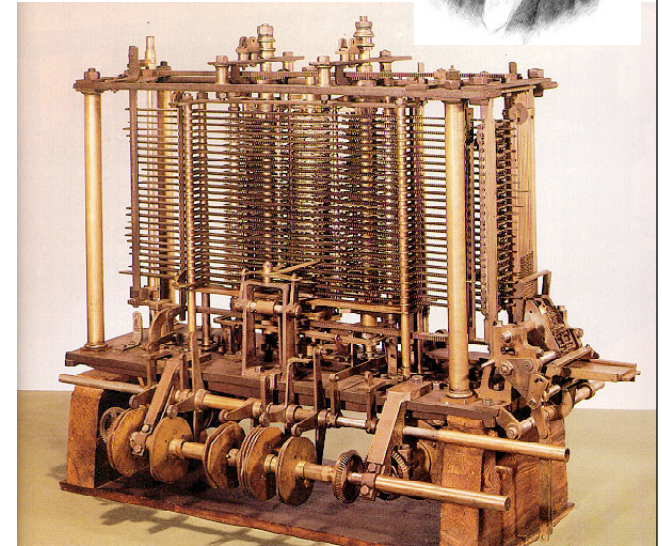

Generation 1: Vacuum Tubes

- The vacuum tube is the first known device to amplify, switch, or modify a signal (by controlling the movements of electrons)
 - The basis from a whole generation of computers
 - But high energy consumption, high heat, large, flaky
 - Still used today in high-end audio amplifiers and other applications
- In the 1930s, Konrad Zuse (German) designed a machine akin to the Analytical Engine of Babbage that was *supposed to* use vacuum tubes
 - But it didn't, due to lack of funds (Zuse was building it in his parents' living room in Berlin)
 - He used electromechanical relays instead
 - He never managed to convince the Nazis to buy/fund his invention!
 - His machines were called the Z1, Z2, and Z3, and destroyed during the WWII bombing of Berlin

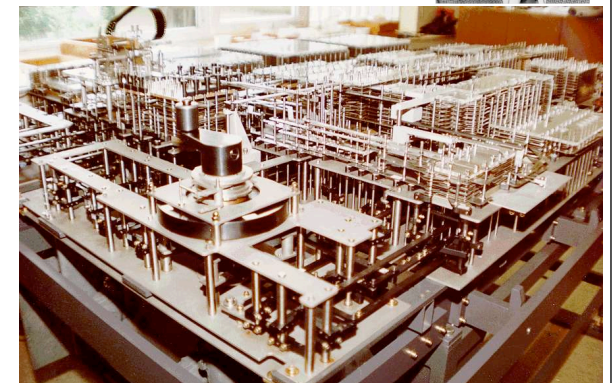
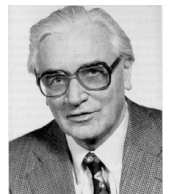



Generation 1: ENIAC

- The ENIAC (Electronic Numerical Integrator and Computer) was unveiled in 1946: the first all-electronic, general-purpose digital computer
 - Designed by Mauchly and Eckert
 - Shares many elements with the ABC computer, which was built to solve linear equations
- Specs
 - 17,468 vacuum tubes
 - 1,800 sq ft
 - 30 tons
 - 174 kilowatt of power
 - 1,000-bit memory
 - Punched card

Generation 1: ENIAC

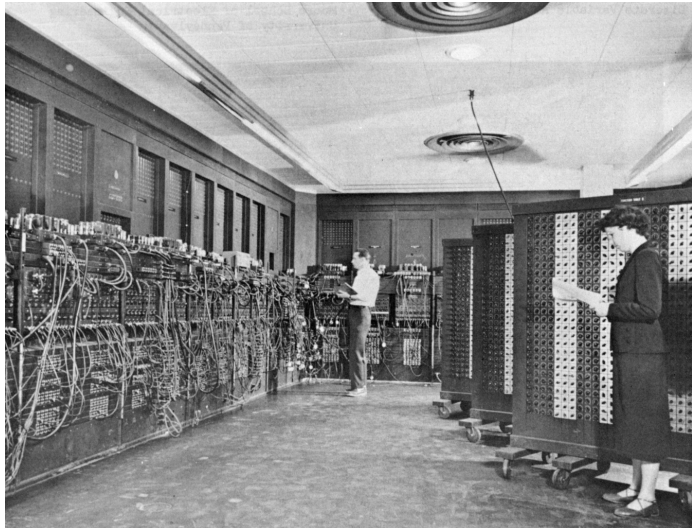

HOW MUCH IS $\sqrt[3]{2589^{16}}$?

The Army's ENIAC can give you the answer in a fraction of a second!

Think that's a stumper? You should see some of the ENIAC's problems! Tens, twenties that if put to paper would run off this page and feet beyond . . . addition, subtraction, multiplication, division—square root, cube root, any root. Solved by an incredibly complex system of circuits operating 18,000 electronic tubes and tipping the scales at 30 tons!

The ENIAC is symbolic of many amazing Army devices with a brilliant future for you! The new Regular Army needs men with aptitude for scientific work, and as one of the first trained in the post-war era, you stand to get in on the ground floor of important jobs

YOUR REGULAR ARMY SERVES THE NATION AND MANKIND IN WAR AND PEACE

which have never before existed. You'll find that an Army career pays off.

The most attractive fields are filling quickly. Get into the swim while the getting's good! 1½, 2 and 3 year enlistments are open in the Regular Army to ambitious young men 18 to 34 (17 with parents' consent) who are otherwise qualified. If you enlist for 3 years, you may choose your own branch of the service, if those still open. Get full details at your nearest Army Recruiting Station.

A GOOD JOB FOR YOU
U. S. Army
CHOOSE THIS
FINE PROFESSION NOW!

OCTOBER 1946

Generation 1: New Concepts

■ The use of binary

- In the 30s **Claude Shannon** (the father of “information theory”) had proposed that the use of **binary arithmetic** and **boolean logic** should be used with electronic circuits

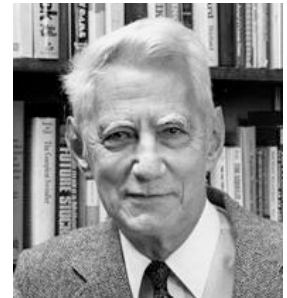

■ The Von-Neumann architecture

- In 1944, **John von Neumann** (Hungarian) learned about ENIAC and joined the group.
- He wrote a memo about computer architecture, formalizing the ideas that came out of ENIAC and transferring them to a wider audience
- This became the Von Neumann machine model, which we still use today
 - Note that Eckert and Mauchly have pretty much been forgotten (they were the real inventors)



The Von-Neumann Architecture

- Three hardware systems
 - A Central Processing Unit (CPU)
 - A memory, which stores **both** program and data
 - An input/output system
- Computers today are still very close to this basic architecture
- We'll come back to it

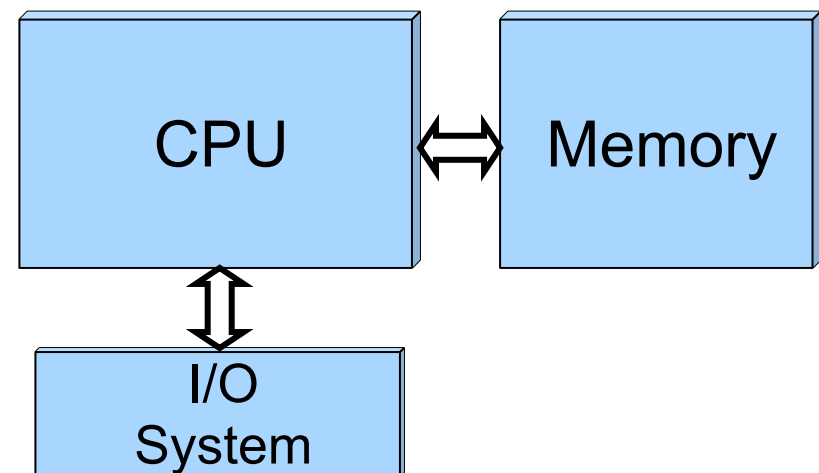

Generation 2: Transistors

- Vacuum tubes have many shortcomings, as we've seen, but on top of it they were not reliable
 - ENIAC often had more downtime than uptime
- In 1948, Bardeen, Brattain, and Shockley invented the transistor at Bell Labs
 - A solid-state version of the vacuum tube that uses silicon, which is a semi-conductor
 - Lower power consumption, smaller, more reliable, cheaper, much lower heat dissipation
- This was the beginning of a new era for electronics and for the computer market

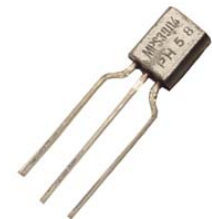



Generation 2: Transistors

- Generation 2 computers were still bulky and expensive, and so there were only in universities, government agencies, and large businesses
- It was the beginning of big computer vendors
- IBM
 - IBM7094: for scientific application (1962)
 - IBM1401: for business applications (1959)
- DEC, Univac
- CDC 6600: first “supercomputer”
 - \$10 million
 - 10 million instructions/sec, 60-bit words, 128kword of memory
 - Build by a team led by Seymour Cray
- Transistor-based computer enabled space travel and many other advances

Generation 2: IBM7094

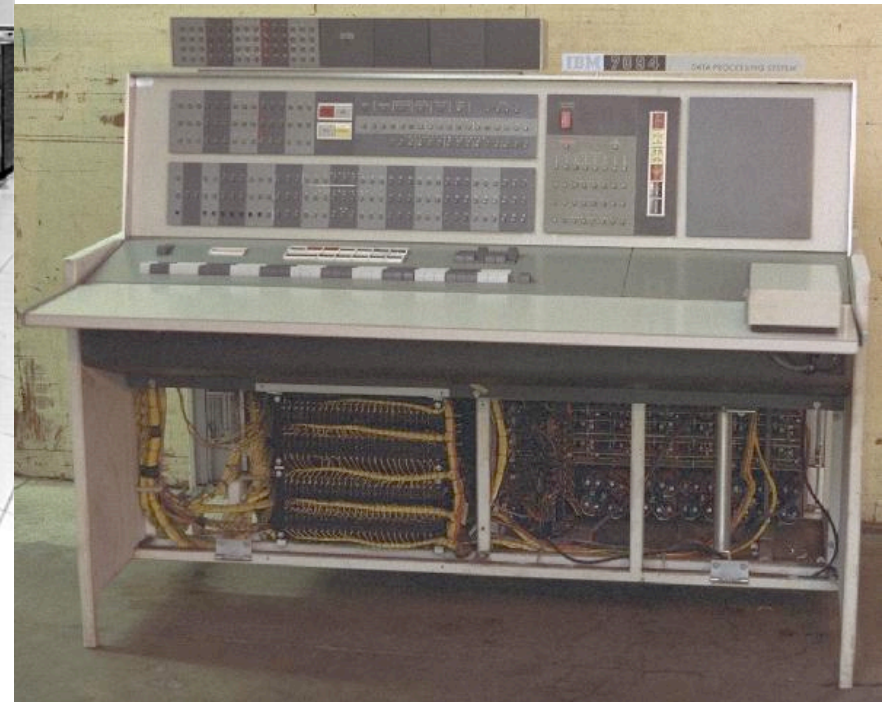

Generation 2: IBM1401

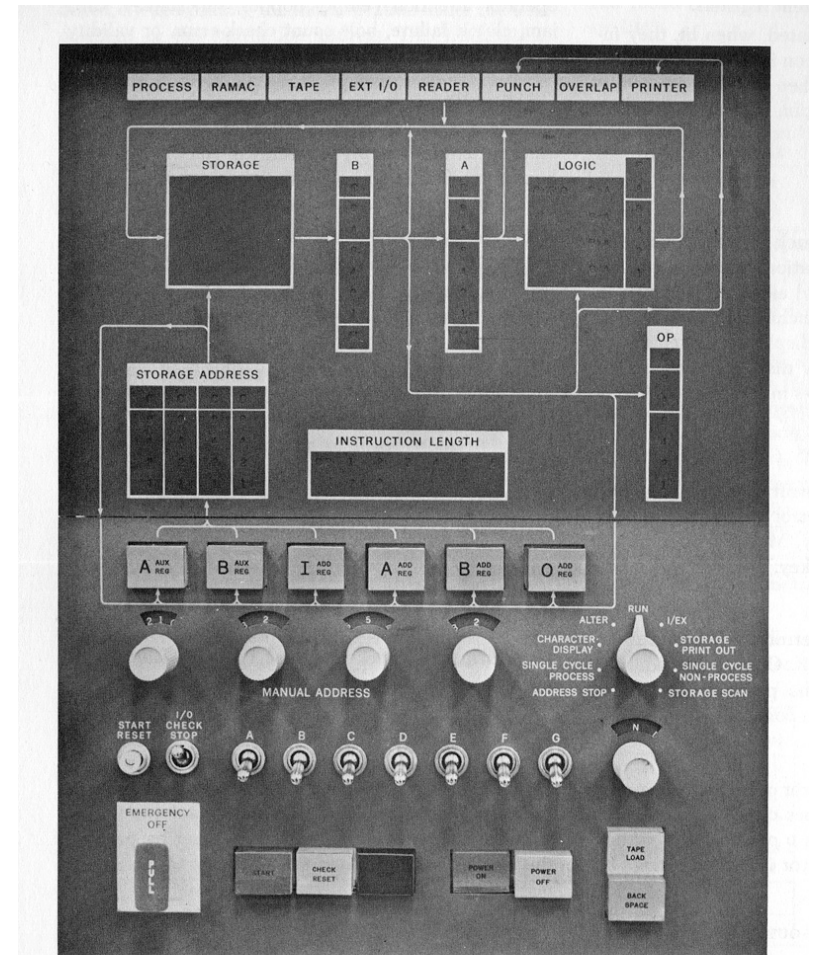
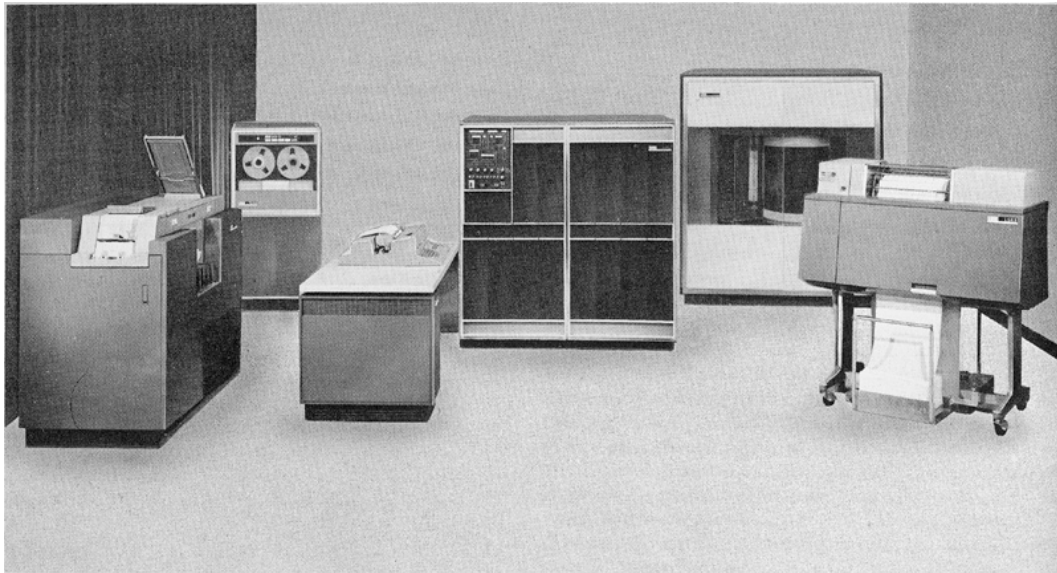

Figure 195. IBM 1401 Console

Generation 2: CDC6600



Generation 3: Integrated Circuits

- In the late 50s, Kilby and Noyce independently came up with the idea of an Integrated Circuit (IC)
- The IC allowed dozens of transistors to exist on a single “silicon chip,” which was smaller than the previously available single transistor
- This led computers to become smaller, faster, and cheaper
- The IBM System/360 was the first computer to be built entirely with ICs
 - Other new concept for these computers: (assembly) code was portable across different machines in the family!



Generation 3: Integrated Circuits

- Seymour Cray created the Cray Research Corporation
- Cray-1: \$8.8 million, 160 million instructions per seconds and 8 Mbytes of memory

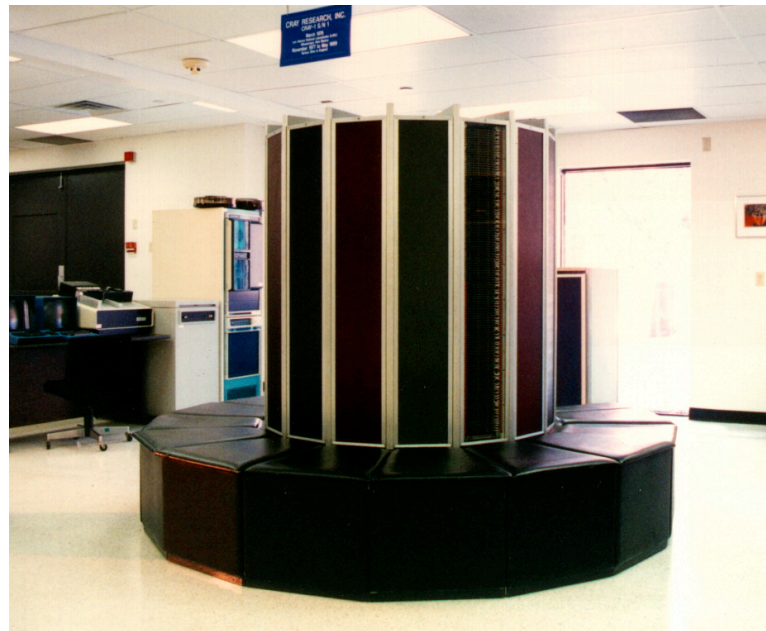

Generation 4: VLSI

- Improvements to IC technology made it possible to integrate more and more transistors in a single chip
 - SSI (Small Scale Integration): 10-100
 - MSI (Medium Scale Integration): 100-1,000
 - LSI (Large Scale Integration): 1,000-10,000
 - VLSI (Very Large Scale Integration): >10,000
 - This keeps increasing, doubling every 24 months or so (the famous Moore's law)
- Many argue that VLSI marks the beginning of Generation 4
- The important point is that with VLSI it became possible to have a full CPU on a single chip, also called a **microprocessor**
- The first microprocessor was created by Intel in 1971 (many people start generation 4 then)
 - 4004 microprocessor: 4-bit, 108KHz
 - RAM chip: 4Kbit





Generation 4: ENIAC on a chip

- In 1997, the 50th anniversary of the ENIAC, students at U. Penn built a single chip equivalent to the ENIAC
- ENIAC
 - 1,800 sqft, 30-ton, 174 kilowatts
- On one-tenth of a chip!
 - 174,569 transistors
 - ~10 times less than typically present on a chip in 1997!

Generation 4: Microprocessors

- With the advent of microprocessors it became possible to build “personal computers”
 - 1977: Apple II
 - 1981: IBM PC





Generation 5?

- The term “Generation 5” is used sometimes to refer to all more or less “sci fi” future developments
 - Voice recognition
 - Artificial intelligence
 - Quantum computing
 - Bio computing
 - Nano technology
 - Learning
 - Natural languages



Summary

- Generation 0: Mechanical Calculators
- Generation 1: Vacuum Tube Computers
- Generation 2: Transistor Computers
- Generation 3: Integrated Circuits
- Generation 4: Microprocessors



Conclusion

- Computers have come a long way, but it is somewhat surprising to realize how the general principles are still the same
 - The Von-Neumann architecture
 - Binary encoding
 - Transistors
- These are the age-old computer architecture principles that we will assume in this course